



GP²



Installation Guidance

GP² is a high quality proprietary gas resistant damp proof membrane, manufactured from low density reinforced polyethylene (LDPE). This products is ideal for use on sites where ground gas contamination is present.

BBA certified high performance damp proof membrane is specifically designed and manufactured to perform as a high performance damp proof membrane, Radon (BRE 211), air and moisture protection system, as well as low level protection to carbon dioxide and methane (NHBC Amber 1). GP² can be used on any site where low levels of ground gas is present. The barrier is sufficiently resistant to the ingress of Radon into a building. On more heavily contaminated sites a passive or active venting system may be required to dilute the gases down to acceptable levels and specific design advice should be sought.

JUTA UK – radon, ground gas, vapour, air and moisture barrier characteristic properties:

- High Chemical Resistance
- High resistance to Ground Gasses
- Long Term Durability (Performance guaranteed for the lifetime of the building)
- Compatible with all building materials
- Manufactured to meet the most up to date British Standards and guidance.

Width	2 m
Length	50 m
Coverage	100 m ² / roll
Weight	30 kg



Additional Products & Accessories:

- **GP² SAM** Gas Resistant Self Adhesive variant of GP¹, is a bituminous gas proof and waterproof sheet, composed of self-adhesive SBS polymer modified bitumen in conjunction with an inner aluminium foil core and external HDPE carrier film. The lower surface finish of siliconized polypropylene release film is removed at the point of use. GP² SAM is used for the Gas/waterproofing of underground structures where harmful ground gasses are anticipated, or available in a 300 mm wide detailing strip to aid with corner sealing and penetration sealing with the GP¹ membrane system.
- **WP SAM** Waterproofing - Self Adhesive Membrane, is a bituminous water proof sheet, which provides resistance to Radon, composed of self-adhesive SBS polymer modified bitumen with an upper surface finish of cross laminated HDPE and a lower surface finish of paper release film. JUTA WP SAM is used for the Radon/waterproofing of underground structures where harmful ground gasses are anticipated, or as a detailing strip to aid with corner sealing and penetration sealing with the GP² and GP⁴ membrane system.
- **GP² Tape** is a double sided thermoplastic sealant tape with high surface tack suitable for sealing membrane overlap joints. All seam joints should be rolled using a 40mm silicone seam roller to remove any trapped air and ensure adhesion between the membranes. Rolls sizes: 50mm x 10m.
- **GP² Lap Tape** is a single sided sealant tape with aluminium foil with high surface tack suitable for sealing membrane joints. All seam joints should be rolled using a 40mm silicone seam roller to remove any trapped air and ensure adhesion between the membranes. Rolls sizes: 75mm x 50m.
- **GP² DPC** is a gas resistant DPC which is used with Juta Gas Barriers depending on site requirements. Roll sizes: 1.3m x 20m.
- **GP² Primer** is a quick drying bitumen primer to give a key prior to applying GP² SAM. Juta GP² Primer can be used /on concrete, cementitious screeds and renders, steel and iron. It should be applied without thinning and should be scrubbed in by brush to ensure an even coverage. Coverage rate 6-10m² / litre depending on porosity of substrate, and drying time 3-4 hours depending on conditions. Supplied in 25 litre drums.
- **GP² Radon Sump** is a lightweight and easy installed HDPE unit. It can be converted to an active sump system if needed using activation of fans. All sumps must be linked by appropriate pipe work. Outlet positions for standard 110mm vent pipes for extraction and dispersion should be connected to the sump relative to site requirements.
- **GP² Void Vent** is a geocomposite void former composed of a cusped High Density Polyethylene (HDPE) Drainage core with a non-woven polypropylene (PP) geotextile separator/filter bonded to one side. The Void Vent is supplied in either 25mm or 40mm void depth. Material is joined by overlapping of the loose edge of geotextile for full coverage, or laid in strips as per the ventilation design. Roll sizes are 0.9m x 50m for the Void Vent 25, and 0.97m x 25m for the Void Vent 40.
- **GP² Protection Board** is a high density board which are supplied in 3.0mm x 1.2m x 2.4m sizes.
- **GP² Protection Fleece** is a 300g nonwoven geotextile and is supplied in 2m x 100m rolls.



General Precautions:

- It is recommended that JUTA Gas Barrier systems are installed in ambient air temperatures in excess of 5°C.
- Ingress of water into the installation area should be prohibited.
- In all cases, the surface onto which the barrier is to be laid should be smooth, dry, clean and free from debris or detritus material which may cause damage to the Barrier.
- In all cases it is recommended the installation of barrier geomembranes is completed by a suitably qualified and accredited installer (NVQ level 2/TWI/CSWIP or equivalent). JUTA UK can offer advice as to suitable/recommended installers.
- Appropriate PPE should be worn at all times during handling, placement and fixing of the Barrier.
- Vehicular traffic directly on top of the Barrier should be avoided.
- Foot traffic directly on top of the Barrier should be restricted.
- Where either Vehicular or Foot traffic is unavoidable, protective measures should be utilised to prevent damage to the Barrier. (Use of protection fleece and/or protection boards)
- GP² Membrane should not be left exposed for prolonged periods and should be covered as soon as practically possible, and within 1 month of installation. Where extended periods of exposure to UV are anticipated, protection measures should be employed to reduce exposure of the GP² membranes.
- Smoking, and naked flames are strictly prohibited.

Preparation:

- Prior to laying the GP² membrane ascertain that any sub floor gas venting or ventilation components are in their respective and appropriate positions. Individual components should be secured to avoid potential disruption or undue movement during the installation process.
- Where geo-composite void formers or graded stone venting layers are being deployed, sand, granite dust, etc., requires to be isolated to prevent fines from infiltrating ventilation voids. An appropriate separation layer / geotextile should be installed to prevent such occurrences.
- Masonry and other substructure elements within the membrane footprint should be checked for sharps and rough surfaces that may cause unintentional damage to overlying membrane(s).
- Warning signs should be displayed to discourage unwarranted foot traffic.
- All unnecessary vehicular access should be denied.



Substrate Preparation:

Substrates for installation of the GP² membrane systems need to have sufficient stability to avoid movement during the installation and subsequent construction works. The substrate preparation should include the following:

- A clean, dry, uniform, smooth surface free from debris and detritus, ponding water (damp or slightly wet is acceptable), oil and grease.
- Open Voids (> 12mm depth or width) must be filled before the installation of the membrane system.
- Where the substrate contains changes in elevation of >12mm, or particle protrusions from the substrate exceed 12mm, a protection fleece should be utilised to protect the membrane from damage from the substrate.
- Generally a sand blinding with a minimum thickness of 30mm, or a 300TT protection fleece would provide a suitable laying surface in lieu of concrete blinding.

We would encourage the use of a subgrade acceptance form prior to installation of the GP² membranes. Any issues of concern with the suitability of the subgrade can be highlighted and addressed prior to laying of the membrane.





Jointing and Sealing using Tapes:

Where design service life does not exceed 25 years:

- A 100mm overlap print line is provided on products to assist with overlapping, jointing and sealing.
- For taped joints, GP² Tape (50mm wide) can be utilised. The GP² Tape is double sided for ease of use.
- To joint using tapes, ensure the first panel of GP² Membrane Barrier is laid, and the surface is clean, dry, and free from dust. Begin by peeling one side of the protective coating from the tape, applying the tape within the 100 mm guide line area; such that the tape is within 100 mm line and the Barrier roll edge. Best practice recommends that the tape should be firmly adhered to the base membrane. This is best achieved by applying pressure with a silicone roller.

- Unroll the second layer of GP² Membrane Barrier ensuring a minimum 50 mm overlap (GP² Tape width) is present along the entire length of the lap. Slowly removing the upper layer of protective film from the Tape, and pressing firmly on the taped joint with a silicone roller will help to remove trapped air and ensure positive adhesion. (Note – taped joints have the highest failure rate when tested to ASTM D4437-08:2013 –therefore it is imperative that pressure sealing with silicone roller is implemented).
- Optional: Finish the joint by application of appropriate sealing tape over the joint to provide a smooth finish. (See below)

JUTA GP² LAP TAPE

JUTA GP² TAPE

JUTA GP² DPM
GP₁/GP₂/ GP₄/ GP DPC -
SUBJECT TO PROJECT
REQUIREMENTS

JUTA GP² LAP TAPE

JUTA GP² DPM
GP₁/GP₂/ GP₄/ GP DPC - SUBJECT
TO PROJECT REQUIREMENTS

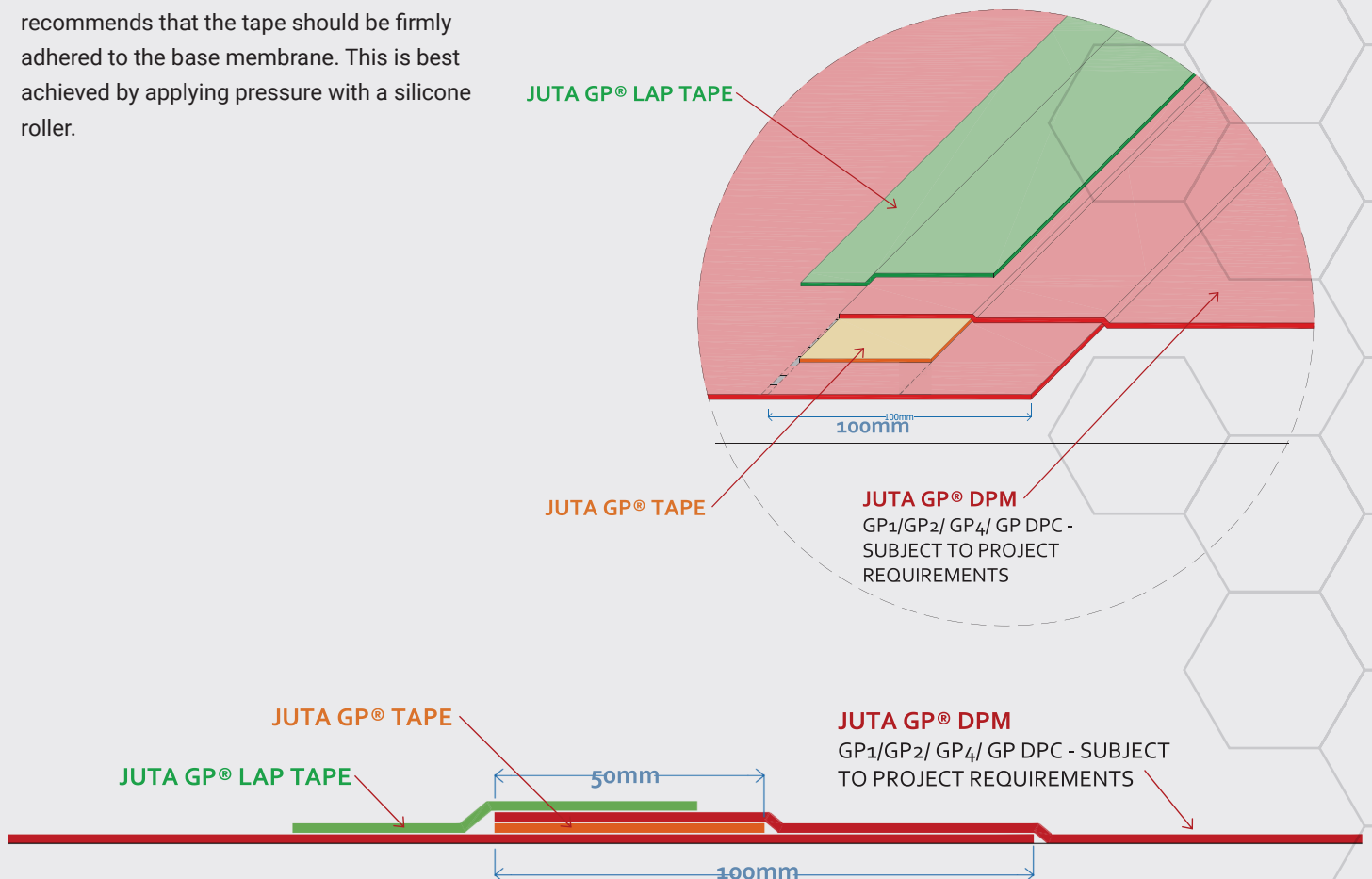



Jointing and Sealing using welding:

Where design service life is required to exceed 60 years:

- Prior to commencing welding work, trials must be completed to determine the operating window for the welding equipment and materials. It is widely acknowledged that ambient air temperature, power supply and the condition of welding equipment can affect the working window.
- Welding window for GP[®] gas barriers is 180-240°C at a suggested rate of 3.0 m/min on low air flow.
- JUTA UK recommends that any heat welding is carried out by a Construction Skills NVQ Level 2 qualified installer. (Or equivalent) The membranes should be overlapped by at least 100mm and care should be taken to ensure a seal between the joint.

- The printed 100mm overlap line should be used as a guide to ensure suitable jointing.
- A minimum welded overlap joint of 50mm wide should be achieved – it should be noted that the suitability of the welded joint is defined by the joint integrity, as tested in accordance with C735 (most commonly air lance –ASTM D4437-08:2013), if a welded joint passes integrity testing, it would be deemed acceptable.

WELDED JOINT
MINIMUM 50mm
WELDED JOINT BY
SPECIALIST INSTALLER

JUTA GP[®] LAP TAPE

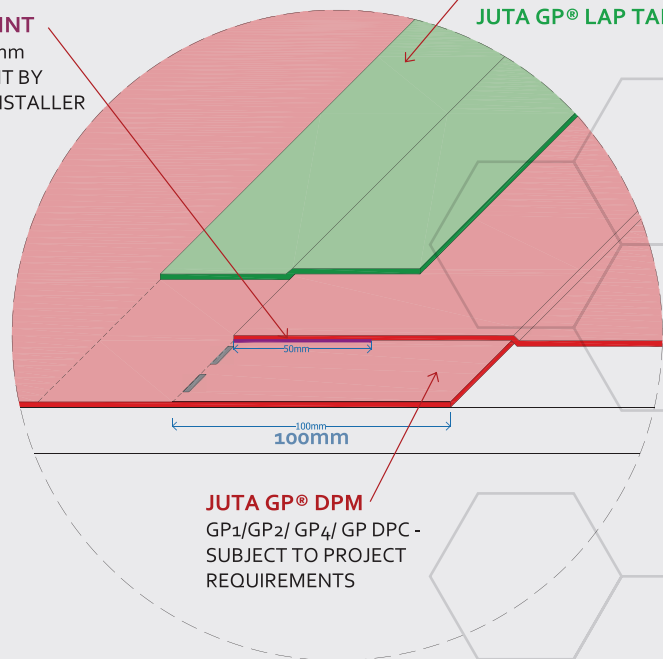

JUTA GP[®] DPM
GP1/GP2/ GP4/ GP DPC -
SUBJECT TO PROJECT
REQUIREMENTS

WELDED JOINT
MINIMUM 50mm WELDED JOINT BY
SPECIALIST INSTALLER

JUTA GP[®] DPM
GP1/GP2/ GP4/ GP DPC - SUBJECT
TO PROJECT REQUIREMENTS

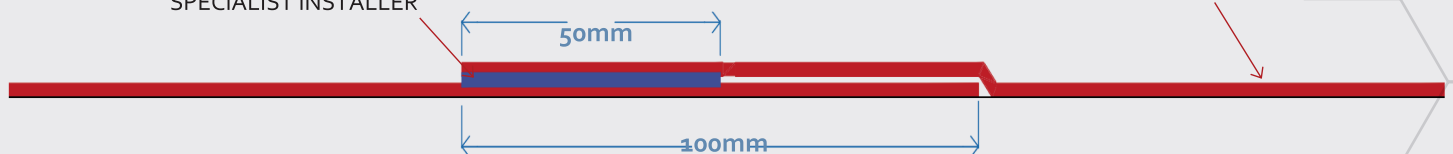



Pre-fabricated corner units:

- Please refer to TD-JUTA.PFC.001 for Pre-Formed Corner Unit detail. Please contact JUTA UK for standard sizes or to request bespoke sizes.
- Build the masonry up to the height of the horizontal joint where the cavity tray is to be built in. Place the preformed upstand unit tight into the corner of the masonry wall.
- Remove the protective paper from the back of the GP[®] Tape and apply it to the upstand unit at a height that will ensure a good overlap when the downstand unit is in place. Remove the protective paper from the face of the tape.
- Place the preformed downstand unit tight into the corner with the horizontal element sitting on the masonry wall. Press the vertical leg of the downstand unit firmly against the upstand unit, starting at the internal corner and working outwards. Wherever possible, a silicone roller should be used to apply pressure and expel trapped air.
- Apply two lengths of double sided tape vertically across both upstand and downstand units, one on each return wall, ready to receive the lengths of cavity tray. When the cavity trays are sealed to the upstand units, join them to the floor membrane.
- If prefabricated units are sealed with thermal jointing – tapes are not required.

Sealing with Self-adhesive membrane:

- Sealing around corners, upstands and penetrations can be achieved with the compatible self-adhesive membrane variant; GP[®]1 SAM for GP[®]1 installation and WP SAM for GP[®]2 and GP[®]4 installation.
- In all cases, the surface onto which the Barrier is to be laid should be smooth, dry, clean and free from debris or detritus material which may cause damage to the Barrier.
- With the GP[®] membrane in place, self-adhesive membrane is cut and applied to the corners/ upstands/penetrations to create a good seal extending a minimum 100mm up the vertical face then overlap and seal to the GP[®] Membrane providing a minimum horizontal 100mm lap.

JUTA SAM /
PRE FABRICATED CORNER UNIT
AS DESCRIBED ABOVE

JUTA GP[®] DPM
GP₁/GP₂/ GP₄ DPM - SUBJECT
TO PROJECT REQUIREMENTS

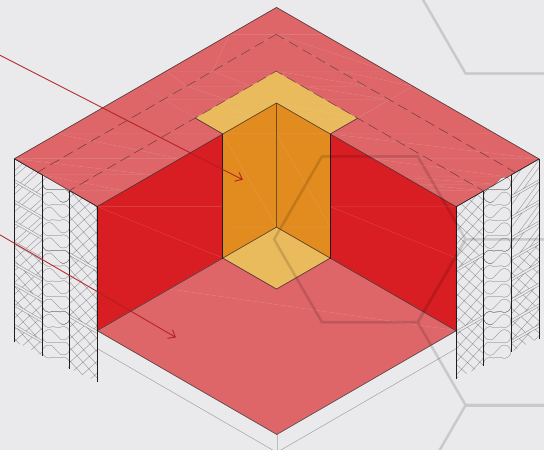



Pre-fabricated top-hats:

- Cut a circular hole in the membrane as close as possible to the pipe, or pipe socket. Ensure that service penetrations do not occur at joints in the membrane.
- With the pipe in position, slide the Preformed Top hat Unit over the pipe (various diameters are available – 110 mm being the most common) mark the extent of the square, horizontal skirt over the membrane and also mark the line of the top of the top hat unit around the pipe.
- Raise the top hat unit and cut four lengths of Double Sided Jointing Tape, one for each side of the horizontal skirt allowing for an overlap at each corner. Cut one length to go round the pipe.
- Start to remove the protective paper from the double sided tape around the pipe and raise it up at an angle so that it will project above the top hat unit when it is stuck to the membrane.
- Release the protective paper from each of the four lengths of double sided tape. Lower the top hat unit, ensuring that the free end of the protective paper around the pipe is reachable, and seal the horizontal skirt to the membrane.
- Gradually remove the remainder of the protective paper from the double sided tape around the pipe.
- Seal the junction of the horizontal skirt and the membrane with the appropriate sealing tape and secure the top hat unit to the pipe with a jubilee clip.
- **If prefabricated top-hats are sealed with thermal jointing – tapes are not required for sealing to the base membrane.**

JUTA GP² TAPE
MANUFACTURED TO SUITE
PENETRATION SIZES AND
SPACING—CONTACT JUTA FOR
FURTHER INFORMATION.

JUTA GP² TAPE
DOUBLE SIDED TAPE CUT
AND POSITIONED TO ALLOW
PRE-FORMED COLLAR TO
SEAL TO GP DPM

JUTA GP² DPM
GP₁/GP₂/ GP₄ DPM - SUBJECT TO
PROJECT REQUIREMENTS

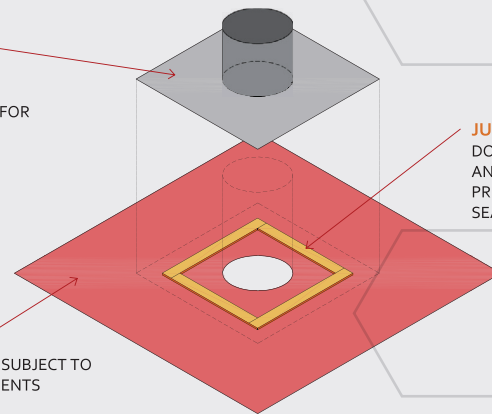



GP² SAM (Self-adhesive Membrane) detailing strip:

Corner detailing and pipe penetrations may be formed and sealed using the 300mm wide GP² SAM ensuring 150mm overlaps onto the horizontal surface.

Top Hat Pipe Penetration Sealing Options:

Pre Formed Pipe collars can also be welded to membrane where required.

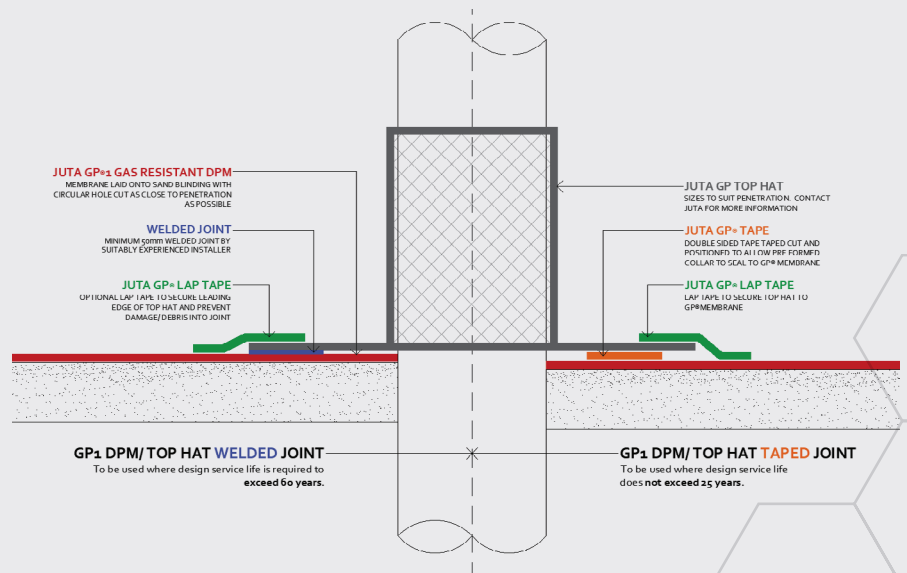

Pile Head/Rebar Penetrations:

Sealing around pile caps and concrete reinforcement is achieved by application of JUTA Liquid Gas Barrier, or a layer of JUTA GP² SAM. In hydrostatic applications, the use of JUTA Crystalline Active Barrier (CAB) may be required to seal the capillaries of the pile cap and to create a monolithic bonding surface prior to application of the gas barrier.

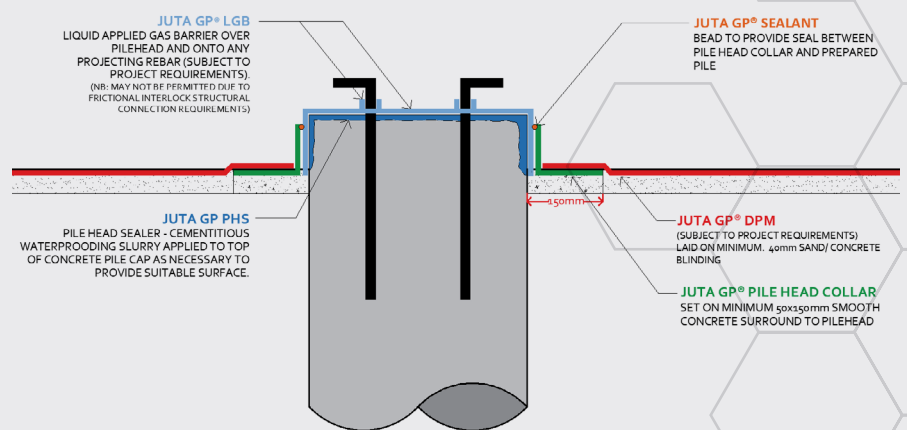



Sealing around stanchion details:

Sealing around stanchion details can be achieved with a couple of options:

OPTION 1:

- Cut square or rectangle in the GP1[®] Membrane to suit the steel baseplate dimensions. Ensure that membrane is laid as tightly as possible around the baseplate.
- With the membrane in place, self-adhesive JUTA GP1[®] SAM is cut and applied to the steel around the flanges to create a good seal extending a minimum 150mm up the vertical face of the steel. The GP1 SAM should then overlap and seal to the GP1[®] Membrane providing a minimum horizontal 100 mm lap.

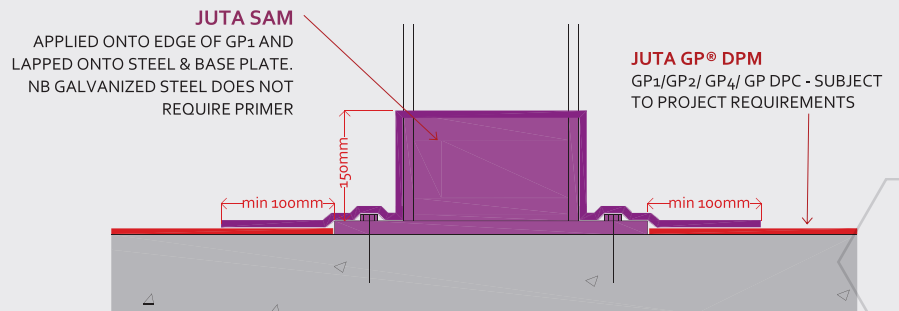

OPTION 2:

- Liquid Applied JUTA LGB is paint applied to the steel baseplate and extending a minimum 100mm onto the concrete foundation. LGB should also extend up the vertical face of the steel a minimum 150 mm.
- Cut square or rectangle in the GP1[®] Membrane to suit the steel baseplate dimensions. Ensure that the cut is tight as possible around the baseplate. Apply 4 lengths of double sided JUTA GP Tape around the perimeter of the baseplate and overlap GP1 membrane and seal using silicone roller.

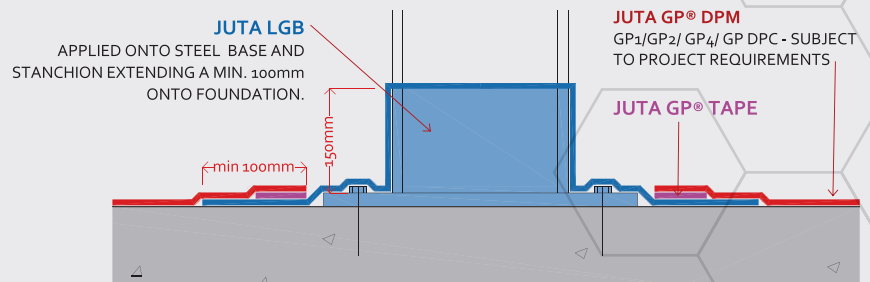



Repairing Punctures:

Should tears, or punctures occur in the membrane, these can be patched using a piece of the same material, sized to overlap at least 150mm beyond the extent of the puncture/tear. Lap should be bonded with JUTA UK GP² tape, in accordance with the instructions above, or welded to provide a continuous sheet.

Note – Where this is not practical (IE – small punctures) isolated repairs may be completed in the same fashion without adhering to the 150mm guide value. It should be noted that the suitability of the repair is determined by its integrity, as tested in accordance with C735, if a repair passes integrity testing, it would be deemed acceptable.

Membrane Integrity / Protection Measures:

It is critical that gas protection membranes retain their physical properties before, during and after installation. In consideration of potential damage that may be caused as a result of foot traffic, during and immediately following installation, the area(s) concerned should be cordoned with access restricted only to authorised persons.

Consideration should be given to the following issues:

The underside of the membrane should be protected from puncture by sharps and /or uneven protrusions. A sand blinding or similar layer should be used. If this is not possible, or it is impractical then protection fleece or boards can be utilised to afford the appropriate level of protection.

Similarly the upper surface of the membrane also requires to be protected from punctures, cuts, hot particles, distortion / stretching, etc.

Damage is frequently caused by sharps carried on the soles of safety footwear, dropped tools, reinforcing steels, and localised pressure transmitted via spacer bars, “high chairs”, etc. Unintentional damage can occur from hot sparks generated during abrasive cutting of steels. In foil core membranes, this type of damage can melt through the upper polythene film exposing the aluminium to the onset of corrosion.

The form(s) of protective covering and physical capabilities should be considered in respect of the conditions on site and the nature of the installation.